



09676E00

Series 6521/3 explosion protected floodlight for use in explosive gas atmospheres of Zone 2 as well as in areas with combustible dust of Zone 21 and Zone 22.

Floodlight Series 6521/3

- Explosion protection in accordance with EN 50 021 and dust protection as per EN 50 281
- For use in
 - Zone 2
 - Zone 21 and Zone 22
- Max. possible lamp capacity
 - high-pressure sodium lamps up to 600 W
 - metal-halide lamps up to 400 W
 - halogen lamps up to 1000 W
- Stainless steel housing, available in three sizes
- Broad or narrow beam reflectors and/or asymmetrical lamp fitting, Standard: broad beam
- Options (all stainless steel components)
 - light visor, detachable: blocks light escape above and lateral from the unit
 - baffle screen, detachable: prevents lateral eye contact (up to 45°); also serves as a protective grating
 - mounting base (rotatable): for permanent installation of the floodlight to walls and columns
 - pole mounting attachment
- Series 6521/3 explosion protected floodlight as spotlight with asymmetrical flat optics reflector



Zones 2, 21 & 22



Selection table								
Version	Lamp capacity			Temperature class at T _a =		T _{o max.} at T _a =	Ordering code	Weight kg
	Lamp-holder	Lamps 1)	Power	40 °C	50 °C	T _o at T _a = 40 °C		
Floodlight size 1	Halogen lamps							
	E 27	QT	max. 150 W	T3	T3	155 °C	6521/31.1-125-0.2	8,400
	E 27	QT	max. 250 W	T2	T2	200 °C		
	High-pressure lamps							
	E 27	HIT	70 W	T4	T3	120 °C	6521/31.1-207-1.2	9,600
	E 27	HST	70 W	--	T3	120 °C	6521/31.1-307-1.2	9,600
	E 27	HIT	100 W	T3	T3	140 °C	6521/31.1-210-1.2	11,000
	E 27	HIE	150 W	T3	T2	165 °C	6521/31.1-215-1.2	12,070
Floodlight size 2	Halogen lamps							
	E 40	QT	500 W	T3	T3	180 °C	6521/32.2-150-0.2	14,200
	High-pressure lamps							
	E 40	HIT / HST	150 W	T3	T3	140 °C	6521/32.2-315-1.2	16,400
	E 40	HIT / HST	250 W	T3	T3	145 °C	6521/32.2-625-1.2	17,900
Floodlight size 3	Halogen lamps							
	E 40	QT	1000 W	T2	T2	230 °C	6521/33.2-111-0.2	18,200
	High-pressure lamps							
	E 40	HIT / HST	250 W	T4	T4	125 °C	6521/33.2-625-1.2	20,700
	E 40	HIT / HST	400 W	T3	T3	160 °C	6521/33.2-640-1.2	21,300
E 40	HST	600 W	T2	T2	190 °C	6521/33.2-360-1.2	24,900	
Add. to ordering code								
Reflector, symmetrical	broad-beamed (standard)						6521/..1.-.-.-.-.	
Reflector, asymmetrical	broad-beamed						6521/..3.-.-.-.-.	
	narrow-beamed						6521/..2.-.-.-.-.	
Compensation	without						6521/.....-0..	
	with						6521/.....-1..	
Cable entry	standard: c)	3x M 20 x 1.5 1x cable entry 1x stopping plug 1x cable entry with blind plugs as test holes						6521/.....-2.
	special: c)	2x M 25 x 1.5 1x cable entry 1x stopping plug 1x M 20 cable entry with blind plugs as test holes						6521/.....-1.
	other:	Cable entries per customer order						6521/.....-9.
Rated voltage	Specify rated voltage							
Please pay attention to the information on the next page.								

- Note
- 1) QT → Halogen lamps
 HIT → Metal halide lamps
 HST → High-pressure sodium lamps
 HIT / HST → Metal halide lamps / High-pressure sodium lamps
- The floodlights are delivered without lamps; mounting bracket is delivered standard. Additional mounting accessories must be ordered separately.
 - Cable gland M 20 x 1.5; connection range \varnothing 6 mm ... 12 mm.
 Cable gland M 25 x 1.5; connection range \varnothing 10 mm ... 16 mm.

Technical Data

Explosion protection	Zone 2:  II 3 G EEx nR II T ¹⁾						
Gas explosion protection	Zone 21:  II 2 D IP 66 T _{O max.} ¹⁾						
Dust explosion protection	Zone 22:  II 3 D IP 66 T _{O max.} ¹⁾						
	1) see selection table						
Certificates							
Gas explosion protection	Zone 2: SNCH 03 ATEX 3515						
Dust explosion protection	Zone 21: SNCH 03 ATEX 3514 Zone 22: SNCH 03 ATEX 3515						
Conformity	CE 0102 to 94/9 EG						
Rated voltage	220 V ... 240 V, AC, + 6 %, 50 Hz, others available on request						
Rated current	Dimensions 6521/3.	Halogen lamps * QT *	Metal-halide lamps * HIT *	High-pressure sodium lamps * HST *			
		Power	I _N	Power	I _N	Power	I _N
	Size 6521/31	100 W 150 W 250 W	0.44 A 0.65 A 1.1 A	70 W 150 W --	1.0 A 1.8 A	70 W -- --	0.98 A
	Size 6521/32	500 W	2.17 A	250 W -- --	3.0 A	150 W 250 W --	1.8 A 3.0 A
	Size 6521/33	500 W -- 1000 W	2.17 A -- 4.35 A	250 W 400 W --	3.0 A 4.2 A	250 W 400 W 600 W --	3.0 A 4.45 A 6.2 A
Power factor cos φ	High-pressure lamps, compensated, cos φ > 0.9						
Protection class	I (with internal PE connection)						
Connection	L1 + N + PE, for 2.5 mm ² single-wire and fine-strand flexible Cage clamp terminals, 2 clamping points						
Material							
Housing	Sheet steel, stainless steel						
Front cover	Safety glass; temperature change resistant						
Gaskets	Silicone						
Reflector	Aluminium, anodized						
Housing lock	Hexagonal socket screws, M 5, stainless steel Hinged enclosure cover						
Installation orientation	Horizontal lamp axis						
Mounting	U-shaped mounting bracket made of stainless steel; pivots around floodlight axis (infinitely adjustable)						
Degree of protection	IP 66 and EN 60 598						
Ambient temperature	- 20 °C ... + 40 °C / 50 °C						

Dimension drawings (all dimensions in mm) - subject to alterations

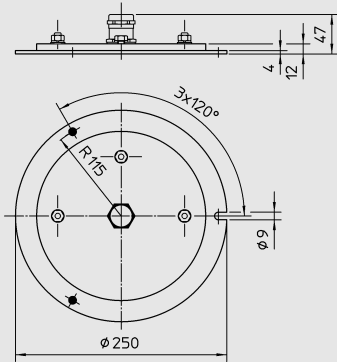

Mounting base (rotatable)

Accessories

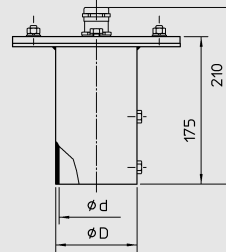





Pole mounting attachment





D	d
97	89
89	76
75	60

09725E00

09724E00

Accessories and Spare Parts

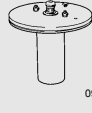
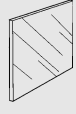
Designation	Illustration	Description				Ordering code	Weight kg	
Halogen lamps QT	 05355E00	Power	Lamp-holder	Voltage	Lighting current			
		150 W	E 27	230 V	2500 lm	4616380	0,040	
		230 W	E 27	230 V	4200 lm	4616400	0,060	
		500 W	E 40	230 V	10000 lm	4616410	0,132	
		1000 W	E 40	230 V	25000 lm	4616390	0,152	
Metal-halide lamps HIT / HIE	 05355E00	Power	Lamp-holder	Voltage	Lighting current			
		70 W	E 27	230 V	6500 lm	4619110	0,176	
		100 W	E 27	230 V	8000 lm	4637760	0,160	
	 04963E00	150 W	E 27	230 V	12000 lm	4637770	0,170	
		 05355E00	150 W	E 40	230 V	14000 lm	4619130	0,206
			250 W	E 40	230 V	20000 lm	4619150	0,200
			400 W	E 40	230 V	31500 lm	4619170	0,235
High-pressure sodium lamps HST	 05355E00	Power	Lamp-holder	Voltage	Lighting current			
		70 W	E 27	230 V	6000 lm	4619100	0,088	
		150 W	E 40	230 V	15000 lm	4619120	0,170	
		250 W	E 40	230 V	28000 lm	4619140	0,213	
		400 W	E 40	230 V	48000 lm	4619160	0,238	
		600 W	E 40	230 V	90000 lm	4637780	0,220	

Accessories and Spare Parts				
Designation	Illustration	Description	Ordering code	Weight kg
Light visor		Stainless steel for Attaches to front cover		
		for 6521/31	6521801580	1,450
		for 6521/32	6521802580	1,900
		for 6521/33	6521803580	2,200
Baffle screen		Stainless steel for Attaches to front cover		
		for 6521/31	6521807580	0,940
		for 6521/32	6521808580	2,100
		for 6521/33	6521809580	2,900
Mounting base (rotatable)		Stainless steel for all sizes	6521801980	3,235
Pole mounting attachment		For installation on end of pole (stainless steel)		
		∅ 60 mm	6521801260	4,430
		∅ 76 mm	6521802260	5,260
		∅ 89 mm	6521803260	4,180
Window		(replacement glass)		
		for 6521/31	6521804580	1,530
		for 6521/32	6521805580	3,100
		for 6521/33	6521806580	5,600
Cable gland		Brass, nickel-plated with O-ring		
		M 20	3507960	0,010
		M 25	3507970	0,010
Stopping plug		Brass, nickel-plated with O-ring		
		M 20	3546510	0,010
		M 25	3546520	0,010

We reserve the right to make alterations to the technical data, weights, dimensions, designs and products available without notice. The illustrations cannot be considered binding.