



01777E00

EEx d Enclosures in Light Metal Flameproof Encapsulation Series 8214

- Explosion protection to
 - CENELEC
 - IEC
- Can be used in Zone 1 and Zone 2
- Aluminium enclosures
- Various enclosure lengths and diameters
- Front plate versions:
 - Square: totally enclosed, with spindle, inspection window, and inspection window with spindle bushings
 - Round: totally enclosed, inspection window, bearing-supported shafts







STAHL

Series 8214 flameproof enclosures are designed for panel mounting.

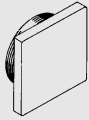
They are available with different front plate options for all normal applications, e.g. with inspection window for indicating instruments, with spindles for potentiometers or keypads, with bearing-supported shafts for incremental shaft encoders or motors.

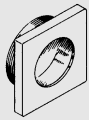
Zones 1 & 2

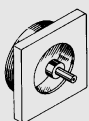
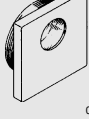

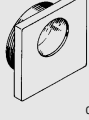







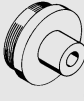

Selection table

Version	Front plate available types	Available types	Length of enclosure mm	Ordering code	Weight kg
 <p>8214/12 EEx d enclosure for flush mounting, pipe diameter 140 mm</p> <p>01787E00</p>	 <p>05292E00</p>	Square front plate, plain	197	8214/121- . - 701	4,500
		257	8214/122- . - 701	5,000	
		327	8214/123- . - 701	6,000	
		477	8214/124- . - 701	7,500	
	 <p>05293E00</p>	Square front plate with spindles	197	8214/121- . - 711	4,500
		257	8214/122- . - 711	5,000	
		327	8214/123- . - 711	6,000	
		477	8214/124- . - 711	7,500	
	 <p>05294E00</p>	Front plate with inspection window Ø 95 mm	197	8214/121- . - 101	4,500
		257	8214/122- . - 101	5,000	
		327	8214/123- . - 101	6,000	
		477	8214/124- . - 101	7,500	
	 <p>05295E00</p>	Front plate with inspection window Ø 95 mm and central spindle	197	8214/121- . - 111	4,500
		257	8214/122- . - 111	5,000	
		327	8214/123- . - 111	6,000	
		477	8214/124- . - 111	7,500	
	 <p>05296E00</p>	Front plate with inspection window Ø 95 mm and central double spindle	197	8214/121- . - 121	4,500
		257	8214/122- . - 121	5,000	
	 <p>05297E00</p>	Front plate with inspection window Ø 52 mm	197	8214/121- . - 401	4,500
		257	8214/122- . - 401	5,000	
		327	8214/123- . - 401	6,000	
		477	8214/124- . - 401	7,500	
	 <p>05298E00</p>	Front plate with inspection window Ø 52 mm and spindles	197	8214/121- . - 411	4,500
		257	8214/122- . - 411	5,000	
		327	8214/123- . - 411	6,000	
		477	8214/124- . - 411	7,500	
	 <p>05299E00</p>	Front plate with inspection window Ø 74 mm	197	8214/121- . - 501	4,500
		257	8214/122- . - 501	5,000	
327		8214/123- . - 501	6,000		
477		8214/124- . - 501	7,500		
Add. to ordering code					
Empty enclosure				8214/ . . . -1- . . .	
Enclosure with components				8214/ . . . -2- . . .	



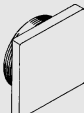

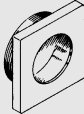
EEx d Enclosures in Light Metal Flameproof Encapsulation Series 8214

Selection table

Version	Front plate available types	Available types	Length of enclosure mm	Ordering code	Weight kg		
 <p>8214/12 EEx d enclosure for flush mounting, pipe diameter 140 mm</p> <p>01787E00</p>	 <p>05304E00</p>	Front plate with inspection window Ø 74 mm and spindles	197	8214/121- . - 511	4,500		
			257	8214/122- . - 511	5,000		
			327	8214/123- . - 511	6,000		
			477	8214/124- . - 511	7,500		
	 <p>8214/13 EEx d enclosure for flush mounting, pipe diameter 240 mm</p> <p>01779E00</p>	 <p>05305E00</p>	Front plate with inspection window Ø 74 mm and central double spindle	197	8214/121- . - 521	4,500	
				257	8214/122- . - 521	5,000	
		 <p>05306E00</p>	Round front plate with inspection window Ø 29 / 30 mm for tube connection	197	8214/121- . - 601	4,500	
				257	8214/122- . - 601	5,000	
		 <p>05307E00</p>	Closed round flange with single bearing supported shaft	197	8214/121- . - 241	4,500	
				257	8214/122- . - 241	5,000	
			 <p>05307E00</p>	Closed round flange with double bearing supported shaft	197	8214/121- . - 231	4,500
					257	8214/122- . - 231	5,000
			327	8214/123- . - 231	6,000		
			477	8214/124- . - 231	7,500		
 <p>8214/13 EEx d enclosure for flush mounting, pipe diameter 240 mm</p> <p>01779E00</p>	 <p>05292E00</p>	Square front plate, plain	303	8214/131- . - 701	13,700		
			403	8214/132- . - 701	16,900		
			473	8214/133- . - 701	18,400		
			573	8214/134- . - 701	21,600		
	 <p>05293E00</p>	Square front plate with spindles	303	8214/131- . - 711	13,700		
			403	8214/132- . - 711	16,900		
			473	8214/133- . - 711	18,400		
			573	8214/134- . - 711	21,600		
	 <p>05294E00</p>	Front plate with inspection window Ø 150 mm	303	8214/131- . - 301	13,700		
			403	8214/132- . - 301	16,900		
			473	8214/133- . - 301	18,400		
			573	8214/134- . - 301	21,600		
 <p>05295E00</p>	Front plate with inspection window Ø 150 mm and central spindle	303	8214/131- . - 311	13,700			
		403	8214/132- . - 311	16,900			
		473	8214/133- . - 311	18,400			
		573	8214/134- . - 311	21,600			
Add. to ordering code							
	Empty enclosure			8214/ . . . -1- . . .			
	Enclosure with components			8214/ . . . -2- . . .			

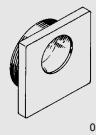
STAHL

Selection table					
Version	Front plate available types	Available types	Length of enclosure mm	Ordering code	Weight kg
 <p>8214/13 EEx d enclosure for flush mounting, pipe diameter 240 mm</p>	 <p>05299E00</p>	Front plate with inspection window Ø 74 mm	303	8214/131- . - 501	13,700
			403	8214/132- . - 501	16,900
			473	8214/133- . - 501	18,400
			573	8214/134- . - 501	21,600
	 <p>05304E00</p>	Front plate with inspection window Ø 74 mm and spindles	303	8214/131- . - 511	13,700
			403	8214/132- . - 511	16,900
			473	8214/133- . - 511	18,400
			573	8214/134- . - 511	21,600
	 <p>05307E00</p>	Closed round flange with double bearing supported shaft	303	8214/131- . - 231	15,400
			403	8214/132- . - 231	18,800
			473	8214/133- . - 231	24,000
			573	8214/134- . - 231	27,200
Add. to ordering code					
	Empty enclosure			8214/ . . . -1- . . .	
	Enclosure with components			8214/ . . . -2- . . .	



EEx d Enclosures in Light Metal Flameproof Encapsulation Series 8214

Technical Data					
Enclosure type	8214/12. (∅ 140 mm)			8214/13. (∅ 240 mm)	
Explosion protection	Empty enclosure	II 2 G EEx de IIC or EEx d IIC		II 2 G EEx de [ia / ib] IIC T6 or T5	
	Enclosure with components	II 2 G EEx de [ia / ib] IIC T6 or T5			
Certificates	Empty enclosure	PTB 02 ATEX 1101 U			
	Enclosure with components	PTB 02 ATEX 1102			
Other certificates	IECEX, FTZU (Czech Republic), SEV (Switzerland), TÜV Wien (Austria), BKI (Hungary)				
Material	Aluminium				
Housing	Aluminium				
Inspection window	Borosilikcate glass or quartz glass				
Surface finish	Primer with bonding coat, light grey stove enamel textured finish, RAL 7032				
Length	197 mm ... 477 mm			303 mm ... 573 mm	
Diameter	∅ 140			∅ 240	
Special fixing	M 4 Allen screws			M 5 Allen screws	
Mounting	Square flange:	Panel mounting			
	Round flange:	Flange mounting			
Rated working voltage	max. 660 V				
Rated working current	max. 32 A				
max. power dissipation	Type	max. power dissipation for		Type	max. power dissipation for
		T 5	T 6	T 5	T 6
	8214/121	51 W	34 W	8214/131	93 W / 170 W*
	8214/122	67 W	45 W	8214/132	132 W / 205 W*
	8214/123	88 W	60 W	8214/133	148 W / 230 W*
	8214/124	114 W	79 W	8214/134	160 W / 260 W*
					108 W / 170 W*
				* for version without inspection window	
Barrier bushing	Type 8171/20-ZL: 22 x 10 A, 400 V or Type 8171/02-AA: 14 x 30 A, 660 V			Type 8171/20-ZL: 22 x 10 A, 400 V or Type 8171/02-AA: 14 x 30 A, 660 V	
Flexible lead	directly to bushings 8171/20-ZL: 1 x 1,5 mm ² 8171/02-AA: 1 x 2,5 mm ²			directly to bushings 8171/20-ZL: 1 x 1,5 mm ² 8171/02-AA: 1 x 2,5 mm ²	
Cable entries					
Standard	3 x M 20 x 1,5 cable glands			3 x M 20 x 1,5 cable glands	
Special	max. 5 x M 25 x 1,5 cable glands			max. 7x M 25 x 1,5 cable glands	
Degree of protection	IP 65 (IP 54 with shaft fitted)			IP 65 (IP 54 with shaft fitted)	

Dimension drawings (all dimensions in mm) - subject to alterations

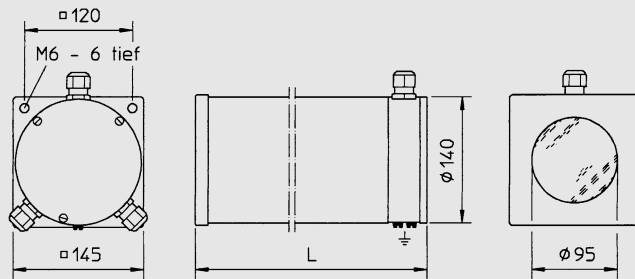

Type	L
8214/121-...1	197
8214/122-...1	257
8214/123-...1	327
8214/124-...1	477

04485E00

EEx d enclosure, 8214/12.

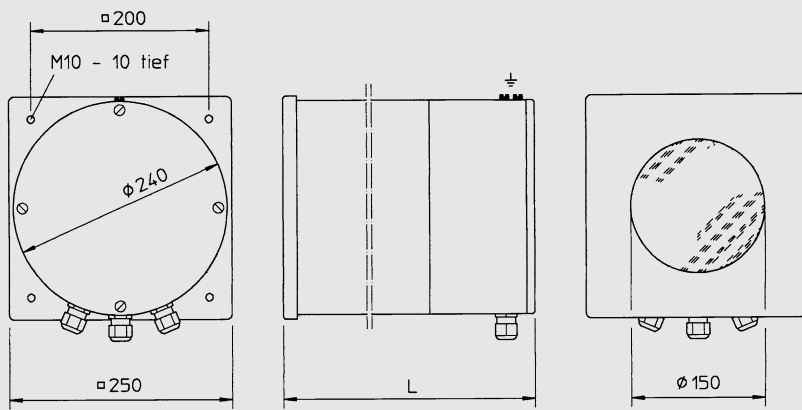

Type	L
8214/131-...1	303
8214/132-...1	403
8214/133-...1	473
8214/134-...1	573

04484E00

EEx d enclosure, 8214/13.

We reserve the right to make alterations to the technical data, weights, dimensions, designs and products available without notice. The illustrations cannot be considered binding.

